

Low-Power Linear Active Thermistor™ ICs

Features

- Tiny Analog Temperature Sensor
- Available Packages: SC-70-5, TO-92-3
- Wide Temperature Measurement Range:
 - -40°C to +125°C
- Accuracy:
 - ±2°C (max.), 0°C to +70°C (**MCP9700A/9701A**)
 - ±4°C (max.), 0°C to +70°C (**MCP9700/9701**)
- Optimized for Analog-to-Digital Converters (ADCs):
 - 10.0 mV/°C (typ.) **MCP9700/9700A**
 - 19.5 mV/°C (typ.) **MCP9701/9701A**
- Wide Operating Voltage Range:
 - $V_{DD} = 2.3V$ to 5.5V **MCP9700/9700A**
 - $V_{DD} = 3.1V$ to 5.5V **MCP9701/9701A**
- Low Operating Current: 6 μA (typ.)
- Optimized to Drive Large Capacitive Loads

Typical Applications

- Hard Disk Drives and Other PC Peripherals
- Entertainment Systems
- Home Appliance
- Office Equipment
- Battery Packs and Portable Equipment
- General Purpose Temperature Monitoring

Typical Application Circuit

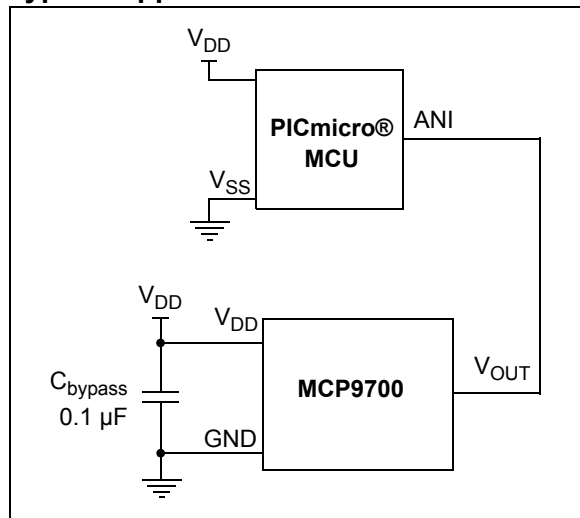

Description

The MCP9700/9700A and MCP9701/9701A family of Linear Active Thermistor™ Integrated Circuit (IC) is an analog temperature sensor that converts temperature to analog voltage. It's a low-cost, low-power sensor with an accuracy of ±2°C from 0°C to +70°C (MCP9700A/9701A) ±4°C from 0°C to +70°C (MCP9700/9701) while consuming 6 μA (typ.) of operating current.

Unlike resistive sensors (such as thermistors), the Linear Active Thermistor IC does not require an additional signal-conditioning circuit. Therefore, the biasing circuit development overhead for thermistor solutions can be avoided by implementing this low-cost device. The voltage output pin (V_{OUT}) can be directly connected to the ADC input of a microcontroller. The MCP9700/9700A and MCP9701/9701A temperature coefficients are scaled to provide a 1°C/bit resolution for an 8-bit ADC with a reference voltage of 2.5V and 5V, respectively.

The MCP9700/9700A and MCP9701/9701A provide a low-cost solution for applications that require measurement of a relative change of temperature. When measuring relative change in temperature from +25°C, an accuracy of ±1°C (typ.) can be realized from 0°C to +70°C. This accuracy can also be achieved by applying system calibration at +25°C.

In addition, this family is immune to the effects of parasitic capacitance and can drive large capacitive loads. This provides Printed Circuit Board (PCB) layout design flexibility by enabling the device to be remotely located from the microcontroller. Adding some capacitance at the output also helps the output transient response by reducing overshoots or undershoots. However, capacitive load is not required for sensor output stability.

Package Type

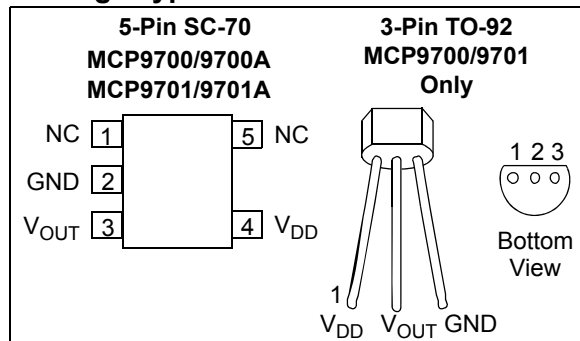

MCP9700/9700A and MCP9701/9701A

1.0 ELECTRICAL CHARACTERISTICS

Absolute Maximum Ratings †

V_{DD} : 6.0V
 Storage temperature: -65°C to +150°C
 Ambient Temp. with Power Applied:.. -40°C to +125°C
 Junction Temperature (T_J):..... 150°C
 ESD Protection On All Pins (HBM:MM):.... (4 kV:200V)
 Latch-Up Current at Each Pin: ±200 mA

†**Notice:** Stresses above those listed under “Maximum Ratings” may cause permanent damage to the device. This is a stress rating only and functional operation of the device at those or any other conditions above those indicated in the operational listings of this specification is not implied. Exposure to maximum rating conditions for extended periods may affect device reliability.

DC ELECTRICAL CHARACTERISTICS

Electrical Specifications: Unless otherwise indicated:						
MCP9700/9700A: V_{DD} = 2.3V to 5.5V, GND = Ground, T_A = -40°C to +125°C and No load.						
MCP9701/9701A: V_{DD} = 3.1V to 5.5V, GND = Ground, T_A = -10°C to +125°C and No load.						
Parameter	Sym	Min	Typ	Max	Unit	Conditions
Power Supply						
Operating Voltage Range	V_{DD}	2.3	—	5.5	V	MCP9700/9700A MCP9701/9701A
	V_{DD}	3.1	—	5.5	V	
Operating Current	I_{DD}	—	6	12	µA	
Power Supply Rejection	$\Delta^\circ\text{C}/\Delta V_{DD}$	—	0.1	—	°C/V	
Sensor Accuracy (Notes 1, 2)						
T_A = +25°C	T_{ACY}	—	±1	—	°C	
T_A = 0°C to +70°C	T_{ACY}	-2.0	—	+2.0	°C	MCP9700A/9701A
T_A = -40°C to +125°C	T_{ACY}	-2.0	—	+4.0	°C	MCP9700A
T_A = -10°C to +125°C	T_{ACY}	-2.0	—	+4.0	°C	MCP9701A
T_A = 0°C to +70°C	T_{ACY}	-4.0	—	+4.0	°C	MCP9700/9701
T_A = -40°C to +125°C	T_{ACY}	-4.0	—	+6.0	°C	MCP9700
T_A = -10°C to +125°C	T_{ACY}	-4.0	—	+6.0	°C	MCP9701
Sensor Output						
Output Voltage, T_A = 0°C	$V_{0^\circ\text{C}}$	—	500	—	mV	MCP9700/9700A
Output Voltage, T_A = 0°C	$V_{0^\circ\text{C}}$	—	400	—	mV	MCP9701/9701A
Temperature Coefficient	T_C	—	10.0	—	mV/°C	MCP9700/9700A
	T_C	—	19.5	—	mV/°C	MCP9701/9701A
Output Non-linearity	V_{ONL}	—	±0.5	—	°C	T_A = 0°C to +70°C (Note 2)
Output Current	I_{OUT}	—	—	100	µA	
Output Impedance	Z_{OUT}	—	20	—	Ω	I_{OUT} = 100 µA, f = 500 Hz
Output Load Regulation	$\Delta V_{OUT}/\Delta I_{OUT}$	—	1	—	Ω	T_A = 0°C to +70°C, I_{OUT} = 100 µA

- Note 1:** The MCP9700/9700A family accuracy is tested with V_{DD} = 3.3V, while the MCP9701/9701A accuracy is tested with V_{DD} = 5.0V.
- 2:** The MCP9700/9700A and MCP9701/9701A family is characterized using the first-order or linear equation, as shown in Equation 4-2.
- 3:** The MCP9700/9700A and MCP9701/9701A family is characterized and production tested with a capacitive load of 1000 pF.
- 4:** SC-70-5 package thermal response with 1x1 inch, dual-sided copper clad, TO-92-3 package thermal response without PCB (lead).

MCP9700/9700A and MCP9701/9701A

DC ELECTRICAL CHARACTERISTICS (CONTINUED)

Electrical Specifications: Unless otherwise indicated: MCP9700/9700A: $V_{DD} = 2.3V$ to $5.5V$, GND = Ground, $T_A = -40^{\circ}C$ to $+125^{\circ}C$ and No load. MCP9701/9701A: $V_{DD} = 3.1V$ to $5.5V$, GND = Ground, $T_A = -10^{\circ}C$ to $+125^{\circ}C$ and No load.						
Parameter	Sym	Min	Typ	Max	Unit	Conditions
Turn-on Time	t_{ON}	—	800	—	μs	
Typical Load Capacitance (Note 3)	C_{LOAD}	—	—	1000	pF	
SC-70 Thermal Response to 63%	t_{RES}	—	1.3	—	s	30°C (Air) to +125°C (Fluid Bath) (Note 4)
TO-92 Thermal Response to 63%	t_{RES}	—	1.65	—	s	

- Note 1:** The MCP9700/9700A family accuracy is tested with $V_{DD} = 3.3V$, while the MCP9701/9701A accuracy is tested with $V_{DD} = 5.0V$.
- 2:** The MCP9700/9700A and MCP9701/9701A family is characterized using the first-order or linear equation, as shown in Equation 4-2.
- 3:** The MCP9700/9700A and MCP9701/9701A family is characterized and production tested with a capacitive load of 1000 pF.
- 4:** SC-70-5 package thermal response with 1x1 inch, dual-sided copper clad, TO-92-3 package thermal response without PCB (leadless).

TEMPERATURE CHARACTERISTICS

Electrical Specifications: Unless otherwise indicated: MCP9700/9700A: $V_{DD} = 2.3V$ to $5.5V$, GND = Ground, $T_A = -40^{\circ}C$ to $+125^{\circ}C$ and No load. MCP9701/9701A: $V_{DD} = 3.1V$ to $5.5V$, GND = Ground, $T_A = -10^{\circ}C$ to $+125^{\circ}C$ and No load.						
Parameters	Sym	Min	Typ	Max	Units	Conditions
Temperature Ranges						
Specified Temperature Range	T_A	-40	—	+125	$^{\circ}C$	MCP9700/9700A (Note)
	T_A	-10	—	+125	$^{\circ}C$	MCP9701/9701A (Note)
Operating Temperature Range	T_A	-40	—	+125	$^{\circ}C$	
Storage Temperature Range	T_A	-65	—	+150	$^{\circ}C$	
Thermal Package Resistances						
Thermal Resistance, SC-70-5	θ_{JA}	—	331	—	$^{\circ}C/W$	
Thermal Resistance, TO-92-3	θ_{JA}	—	131.9	—	$^{\circ}C/W$	

Note: Operation in this range must not cause T_J to exceed Maximum Junction Temperature ($+150^{\circ}C$).

MCP9700/9700A and MCP9701/9701A

2.0 TYPICAL PERFORMANCE CURVES

Note: The graphs and tables provided following this note are a statistical summary based on a limited number of samples and are provided for informational purposes only. The performance characteristics listed herein are not tested or guaranteed. In some graphs or tables, the data presented may be outside the specified operating range (e.g., outside specified power supply range) and therefore outside the warranted range.

Note: Unless otherwise indicated, **MCP9700/9700A:** $V_{DD} = 2.3V$ to $5.5V$; **MCP9701/9701A:** $V_{DD} = 3.1V$ to $5.5V$; GND = Ground, $C_{bypass} = 0.1 \mu F$.

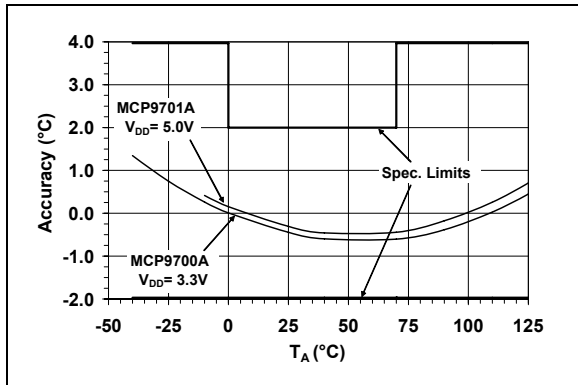

FIGURE 2-1: Accuracy vs. Ambient Temperature (MCP9700A/9701A).

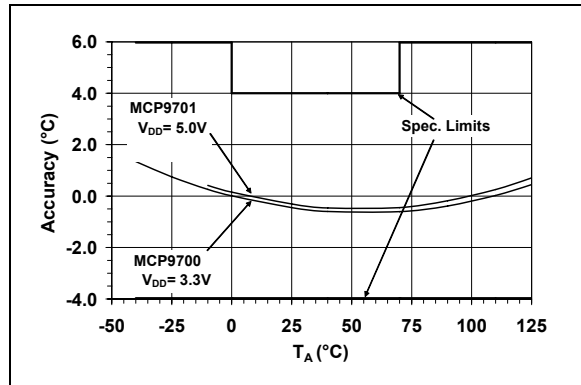

FIGURE 2-4: Accuracy vs. Ambient Temperature (MCP9700/9701).

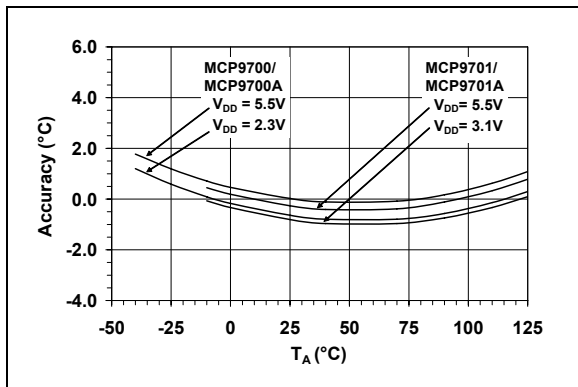

FIGURE 2-2: Accuracy vs. Ambient Temperature, with V_{DD} .

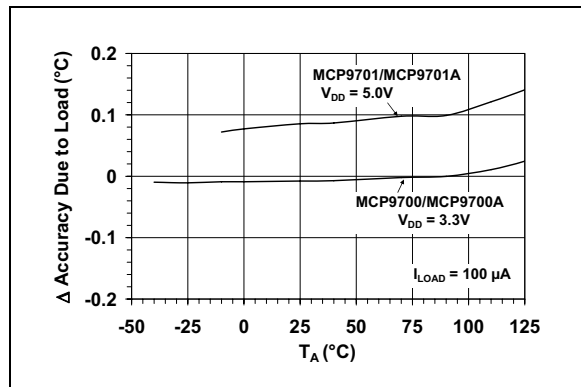

FIGURE 2-5: Changes in Accuracy vs. Ambient Temperature (Due to Load).

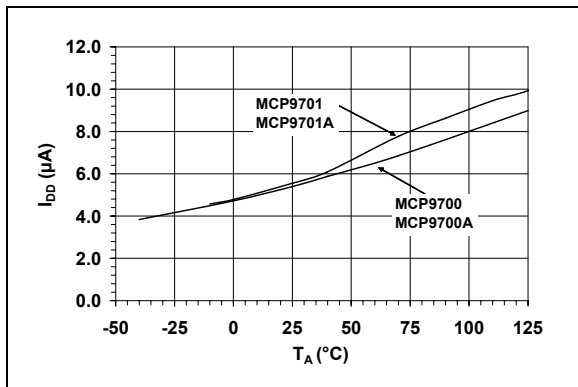

FIGURE 2-3: Supply Current vs. Temperature.

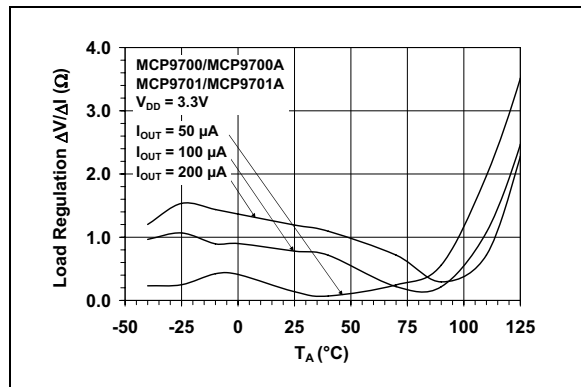

FIGURE 2-6: Load Regulation vs. Ambient Temperature.

MCP9700/9700A and MCP9701/9701A

Note: Unless otherwise indicated, **MCP9700/9700A:** $V_{DD} = 2.3V$ to $5.5V$; **MCP9701/9701A:** $V_{DD} = 3.1V$ to $5.5V$; GND = Ground, $C_{bypass} = 0.1 \mu F$.

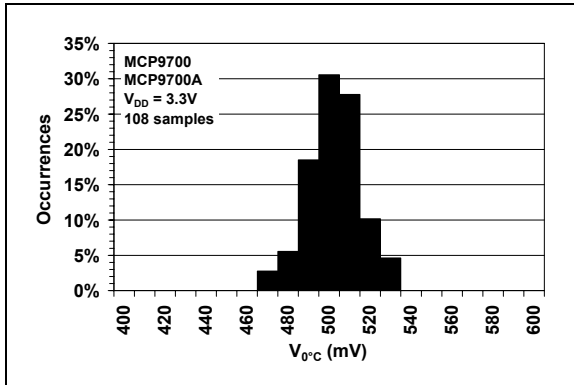

FIGURE 2-7: Output Voltage at $0^{\circ}C$ (MCP9700/9700A).

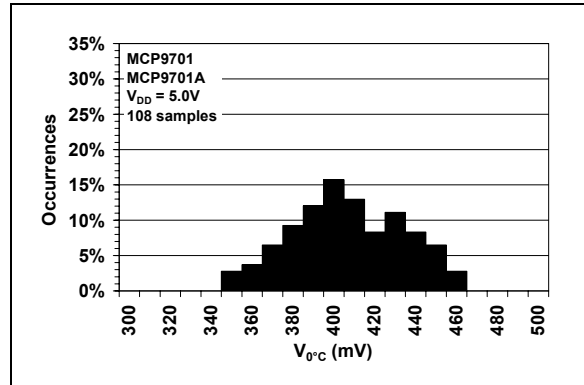

FIGURE 2-10: Output Voltage at $0^{\circ}C$ (MCP9701/9701A).

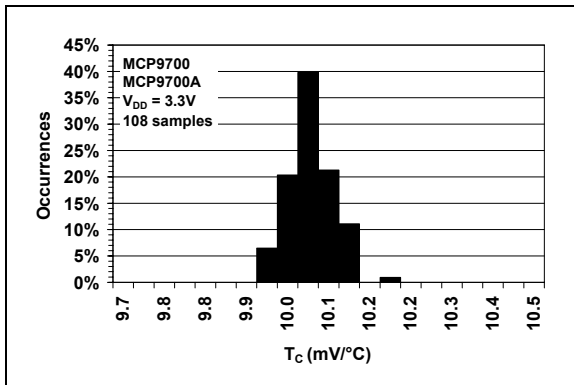

FIGURE 2-8: Occurrences vs. Temperature Coefficient (MCP9700/9700A).

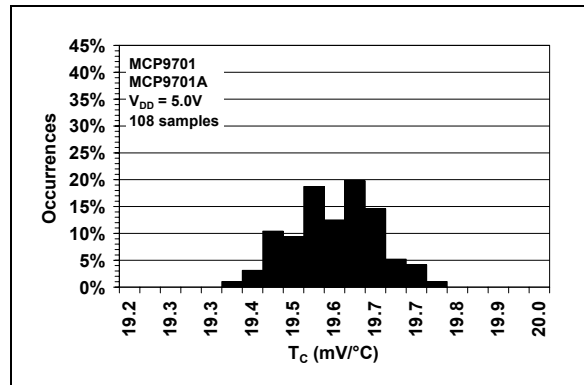

FIGURE 2-11: Occurrences vs. Temperature Coefficient (MCP9701/9701A).

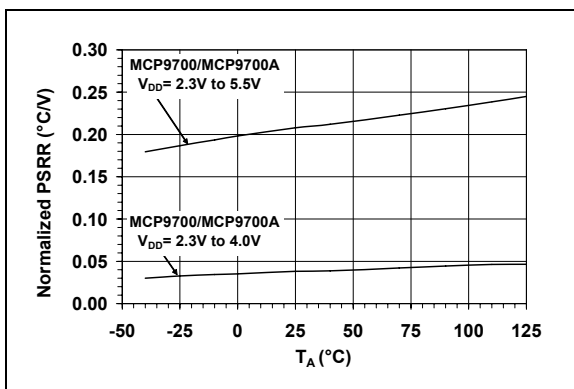

FIGURE 2-9: Power Supply Rejection ($\Delta^{\circ}C/\Delta V_{DD}$) vs. Ambient Temperature.

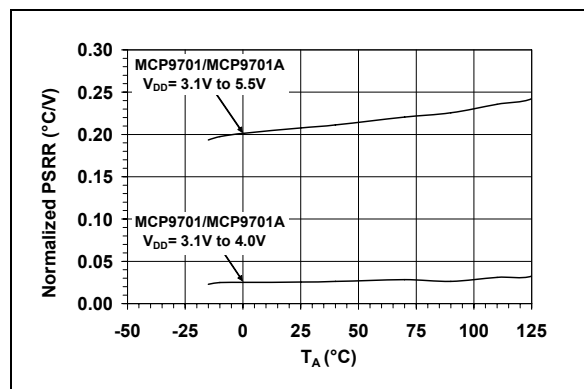

FIGURE 2-12: Power Supply Rejection ($\Delta^{\circ}C/\Delta V_{DD}$) vs. Temperature.

MCP9700/9700A and MCP9701/9701A

Note: Unless otherwise indicated, MCP9700/9700A: $V_{DD} = 2.3V$ to $5.5V$; MCP9701/9701A: $V_{DD} = 3.1V$ to $5.5V$; GND = Ground, $C_{bypass} = 0.1 \mu F$.

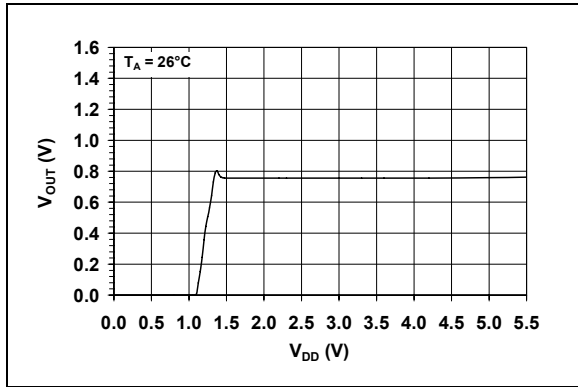

FIGURE 2-13: Output Voltage vs. Power Supply.

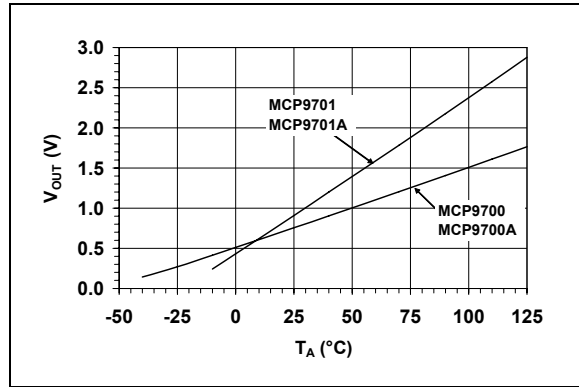

FIGURE 2-16: Output Voltage vs. Ambient Temperature.

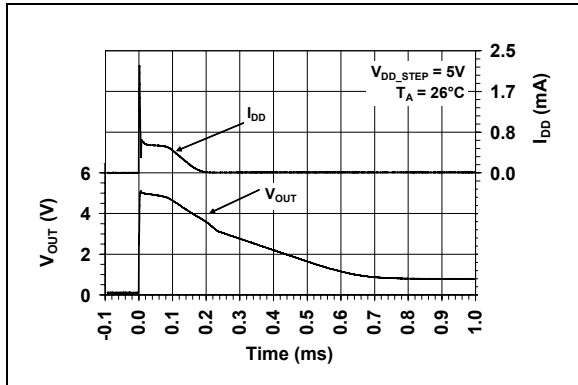

FIGURE 2-14: Output vs. Settling Time to step V_{DD} .

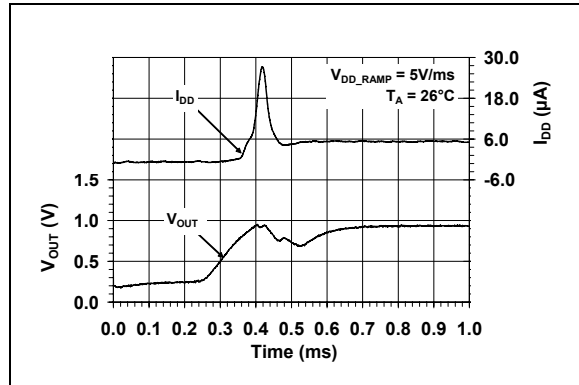

FIGURE 2-17: Output vs. Settling Time to Ramp V_{DD} .

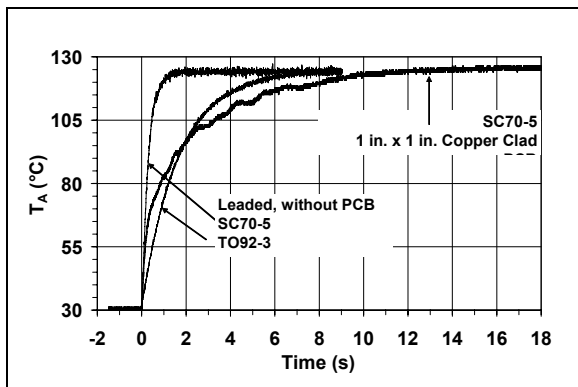

FIGURE 2-15: Thermal Response (Air to Fluid Bath).

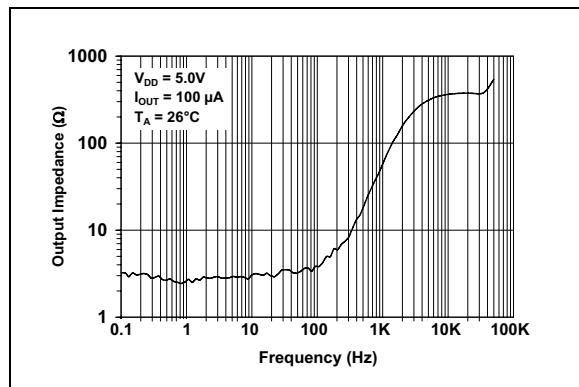

FIGURE 2-18: Output Impedance vs. Frequency.

MCP9700/9700A and MCP9701/9701A

3.0 PIN DESCRIPTIONS

The descriptions of the pins are listed Table 3-1.

TABLE 3-1: PIN FUNCTION TABLE

Pin No. SC-70	Pin No. TO-92	Symbol	Function
1	—	NC	No Connect
2	3	GND	Power Ground Pin
3	2	V _{OUT}	Output Voltage Pin
4	1	V _{DD}	Power Supply Input
5	—	NC	No Connect

3.1 Power Ground Pin (GND)

GND is the system ground pin.

3.2 Output Voltage Pin (V_{OUT})

The sensor output can be measured at V_{OUT}. The voltage range over the operating temperature range for the MCP9700/9700A is 100 mV to 1.75V and for the MCP9701/9701A, 200 mV to 3V .

3.3 Power Supply Input (V_{DD})

The operating voltage as specified in the “**DC Electrical Characteristics**” table is applied to V_{DD}.

MCP9700/9700A and MCP9701/9701A

4.0 APPLICATIONS INFORMATION

The Linear Active Thermistor™ IC uses an internal diode to measure temperature. The diode electrical characteristics have a temperature coefficient that provides a change in voltage based on the relative ambient temperature from -40°C to 125°C. The change in voltage is scaled to a temperature coefficient of 10.0 mV/°C (typ.) for the MCP9700/9700A and 19.5 mV/°C (typ.) for the MCP9701/9701A. The output voltage at 0°C is also scaled to 500 mV (typ.) and 400 mV (typ.) for the MCP9700/9700A and MCP9701/9701A, respectively. This linear scale is described in the first-order transfer function shown in Equation 4-1.

EQUATION 4-1: SENSOR TRANSFER FUNCTION

$$V_{OUT} = T_C \cdot T_A + V_{0^\circ C}$$

Where:

- T_A = Ambient Temperature
- V_{OUT} = Sensor Output Voltage
- $V_{0^\circ C}$ = Sensor Output Voltage at 0°C
- T_C = Temperature Coefficient

4.1 Improving Accuracy

The MCP9700/9700A and MCP9701/9701A accuracy can be improved by performing a system calibration at a specific temperature. For example, calibrating the system at +25°C ambient improves the measurement accuracy to a ±0.5°C (typ.) from 0°C to +70°C, as shown in Figure 4-1. Therefore, when measuring relative temperature change, this family measures temperature with higher accuracy.

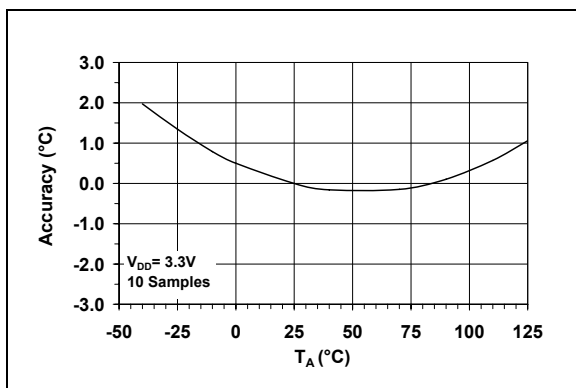

FIGURE 4-1: Relative Accuracy to +25°C vs. Temperature.

The change in accuracy from the calibration temperature is due to the output non-linearity from the first-order equation, as specified in Equation 4-2. The accuracy can be further improved by compensating for the output non-linearity.

For higher accuracy using a sensor compensation technique, refer to AN1001 “IC Temperature Sensor Accuracy Compensation with a PICmicro® Microcontroller” (DS01001). The application note shows that if the MCP9700 is compensated in addition to room temperature calibration, the sensor accuracy can be improved to ±0.5°C (typ.) accuracy over the operating temperature (Figure 4-2).

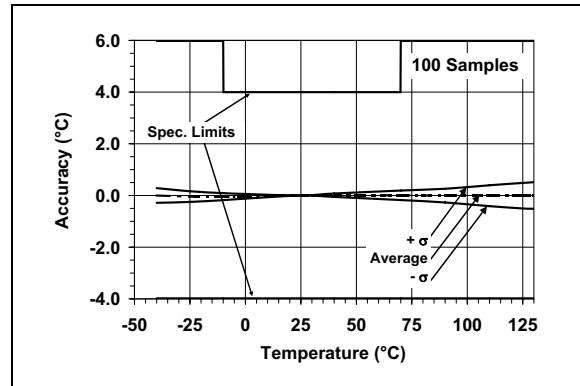

FIGURE 4-2: MCP9700/9700A Calibrated Sensor Accuracy.

The compensation technique provides a linear temperature reading. A firmware look-up table can be generated to compensate for the sensor error.

4.2 Shutdown Using Microcontroller I/O Pin

The MCP9700/9700A and MCP9701/9701A family of low operating current of 6 μA (typ.) makes it ideal for battery-powered applications. However, for applications that require tighter current budget, this device can be powered using a microcontroller Input/Output (I/O) pin. The I/O pin can be toggled to shut down the device. In such applications, the microcontroller internal digital switching noise is emitted to the MCP9700/9700A and MCP9701/9701A as power supply noise. This switching noise compromises measurement accuracy. Therefore, a decoupling capacitor and series resistor will be necessary to filter out the system noise.

4.3 Layout Considerations

The MCP9700/9700A and MCP9701/9701A family does not require any additional components to operate. However, it is recommended that a decoupling capacitor of 0.1 μF to 1 μF be used between the V_{DD} and GND pins. In high-noise applications, connect the power supply voltage to the V_{DD} pin using a 200Ω resistor with a 1 μF decoupling capacitor. A high frequency ceramic capacitor is recommended. It is necessary for the capacitor to be located as close as possible to the V_{DD} and GND pins in order to provide effective noise protection. In addition, avoid tracing digital lines in close proximity to the sensor.

4.4 Thermal Considerations

The MCP9700/9700A and MCP9701/9701A family measures temperature by monitoring the voltage of a diode located in the die. A low-impedance thermal path between the die and the PCB is provided by the pins. Therefore, the sensor effectively monitors the temperature of the PCB. However, the thermal path for the ambient air is not as efficient because the plastic device package functions as a thermal insulator from the die. However, the plastic device package insulates the die and restricts device thermal response. This limitation applies to plastic-packaged silicon temperature sensors. If the application requires measuring ambient air, the PCB needs to be designed with proper thermal conduction to the sensor pins.

The MCP9700/9700A and MCP9701/9701A is designed to source/sink 100 μ A (max.). The power dissipation due to the output current is relatively insignificant. The effect of the output current can be described using Equation 4-2.

EQUATION 4-2: EFFECT OF SELF-HEATING

$$T_J - T_A = \theta_{JA}(V_{DD}I_{DD} + (V_{DD} - V_{OUT})I_{OUT})$$

Where:

- T_J = Junction Temperature
- T_A = Ambient Temperature
- θ_{JA} = Package Thermal Resistance
(331°C/W)
- V_{OUT} = Sensor Output Voltage
- I_{OUT} = Sensor Output Current
- I_{DD} = Operating Current
- V_{DD} = Operating Voltage

At $T_A = +25^\circ\text{C}$ ($V_{OUT} = 0.75\text{V}$) and maximum specification of $I_{DD} = 12 \mu\text{A}$, $V_{DD} = 5.5\text{V}$ and $I_{OUT} = +100 \mu\text{A}$, the self-heating due to power dissipation ($T_J - T_A$) is 0.179°C.

MCP9700/9700A and MCP9701/9701A

5.0 PACKAGING INFORMATION

5.1 Package Marking Information

5-Lead SC-70 (MCP9700/MCP9700A)

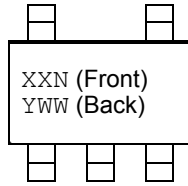

Device	Code
MCP9700/9700A	AUN
MCP9701/9701A	AVN

Note: Applies to 5-Lead SC-70.

Example:

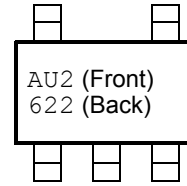

5-Lead SC-70 (MCP9701/MCP9701A)

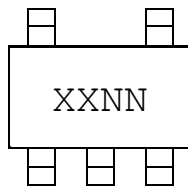

Device	Code
MCP9700/9700A	AUNN
MCP9701/9701A	AVNN

Note: Applies to 5-Lead SC-70.

Example:

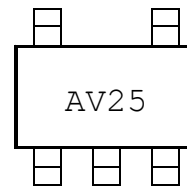

3-Lead TO-92 (MCP9700/MCP9701)

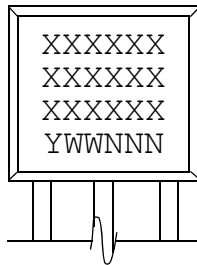

Example

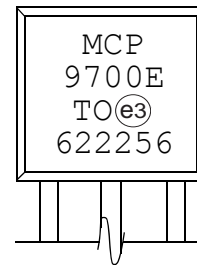

Legend:	XX...X	Customer-specific information
	Y	Year code (last digit of calendar year)
	YY	Year code (last 2 digits of calendar year)
	WW	Week code (week of January 1 is week '01')
	NNN	Alphanumeric traceability code
	(e3)	Pb-free JEDEC designator for Matte Tin (Sn)
	*	This package is Pb-free. The Pb-free JEDEC designator (e3) can be found on the outer packaging for this package.
Note: In the event the full Microchip part number cannot be marked on one line, it will be carried over to the next line, thus limiting the number of available characters for customer-specific information.		

MCP9700/9700A and MCP9701/9701A

5-Lead Plastic Small Outline Transistor (LT) (SC-70)

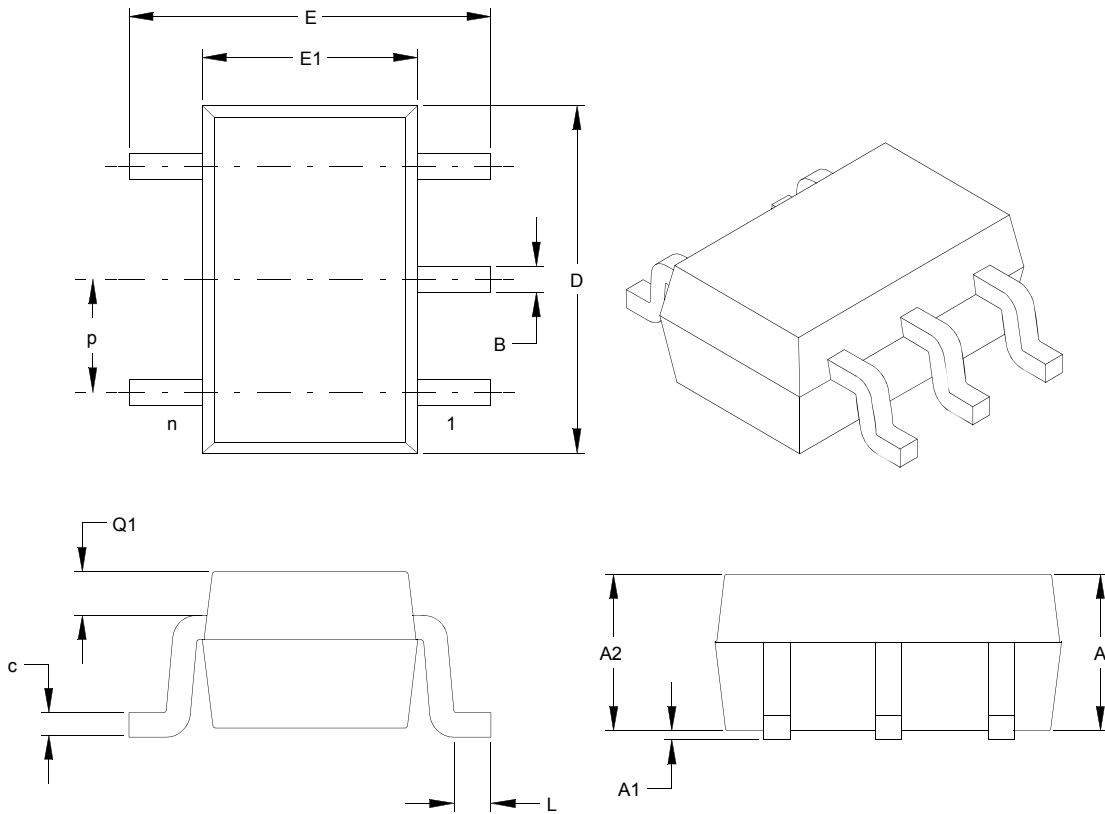

Units		INCHES			MILLIMETERS*		
Dimension Limits		MIN	NOM	MAX	MIN	NOM	MAX
Number of Pins	n	5			5		
Pitch	P	.026 (BSC)			0.65 (BSC)		
Overall Height	A	.031		.043	0.80		1.10
Molded Package Thickness	A2	.031		.039	0.80		1.00
Standoff	A1	.000		.004	0.00		0.10
Overall Width	E	.071		.094	1.80		2.40
Molded Package Width	E1	.045		.053	1.15		1.35
Overall Length	D	.071		.087	1.80		2.20
Foot Length	L	.004		.012	0.10		0.30
Top of Molded Pkg to Lead Shoulder	Q1	.004		.016	0.10		0.40
Lead Thickness	c	.004		.007	0.10		0.18
Lead Width	B	.006		.012	0.15		0.30

* Controlling Parameter

Notes:

Dimensions D and E1 do not include mold flash or protrusions. Mold flash or protrusions shall not exceed .005" (0.127mm) per side.

BSC: Basic Dimension. Theoretically exact value shown without tolerances.

See ASME Y14.5M

JEITA (EIAJ) Standard: SC-70

Drawing No. C04-061

Revised 07-19-05

MCP9700/9700A and MCP9701/9701A

3-Lead Plastic Transistor Outline (TO) (TO-92)

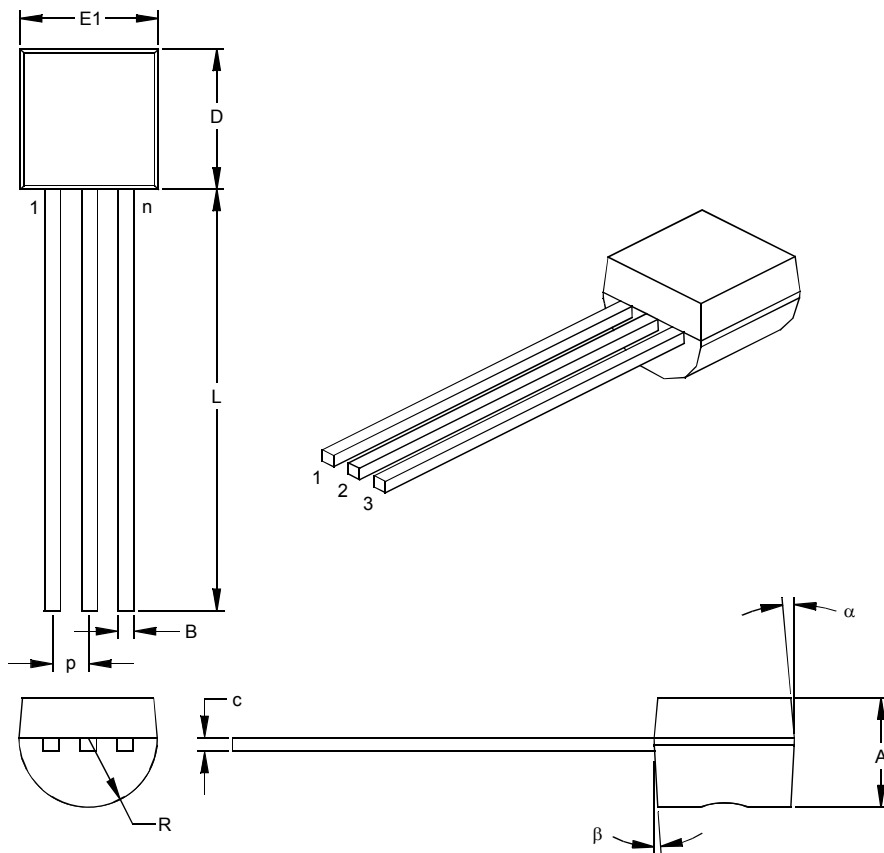

Dimension Limits	Units	INCHES*			MILLIMETERS		
		MIN	NOM	MAX	MIN	NOM	MAX
Number of Pins	n	3			3		
Pitch	p		.050			1.27	
Bottom to Package Flat	A	.130	.143	.155	3.30	3.62	3.94
Overall Width	E1	.175	.186	.195	4.45	4.71	4.95
Overall Length	D	.170	.183	.195	4.32	4.64	4.95
Molded Package Radius	R	.085	.090	.095	2.16	2.29	2.41
Tip to Seating Plane	L	.500	.555	.610	12.70	14.10	15.49
Lead Thickness	c	.014	.017	.020	0.36	0.43	0.51
Lead Width	B	.016	.019	.022	0.41	0.48	0.56
Mold Draft Angle Top	α	4	5	6	4	5	6
Mold Draft Angle Bottom	β	2	3	4	2	3	4

* Controlling Parameter

Notes:

Dimensions D and E1 do not include mold flash or protrusions. Mold flash or protrusions shall not exceed .010" (0.254mm) per side.

JEDEC Equivalent: TO-92

Drawing No. C04-101

MCP9700/9700A and MCP9701/9701A

APPENDIX A: REVISION HISTORY

Revision C (June 2006)

- Added the MCP9700A and MCP9701A devices to data sheet
- Added TO92 package for the MCP9700/MCP9701

Revision B (October 2005)

The following is the list of modifications:

- Added **Section 3.0 “Pin Descriptions”**
- Added the Linear Active Thermistor™ IC trademark
- Removed the 2nd order temperature equation and the temperature coefficient histogram
- Added a reference to AN1001 and corresponding verbiage
- Added Figure 4-2 and corresponding verbiage

Revision A (November 2005)

- Original Release of this Document.

MCP9700/9700A and MCP9701/9701A

NOTES:

MCP9700/9700A and MCP9701/9701A

PRODUCT IDENTIFICATION SYSTEM

To order or obtain information, e.g., on pricing or delivery, refer to the factory or the listed sales office.

<u>PART NO.</u>	-	<u>X</u>	/	<u>XX</u>	Examples:
Device		Temperature Range		Package	
<p>Device:</p> <p>MCP9700T: Linear Active Thermistor™ IC, Tape and Reel, Pb free</p> <p>MCP9700AT: Linear Active Thermistor™ IC, Tape and Reel, Pb free</p> <p>MCP9701T: Linear Active Thermistor™ IC, Tape and Reel, Pb free</p> <p>MCP9701AT: Linear Active Thermistor™ IC, Tape and Reel, Pb free</p> <p>Temperature Range: E = -40°C to +125°C</p> <p>Package: LT = Plastic Small Outline Transistor, 5-lead TO = Plastic Plastic Transistor Outline, 3-lead (MCP9700, MCP9701 only)</p>					<p>a) MCP9700T-E/LT: Linear Active Thermistor™ IC, Tape and Reel, 5LD SC-70 package.</p> <p>b) MCP9700-E/TO: Linear Active Thermistor™ IC, 3LD TO-92 package.</p> <p>c) MCP9700AT-E/LT: Linear Active Thermistor™ IC, Tape and Reel, 5LD SC-70 package.</p> <p>a) MCP9701T-E/LT: Linear Active Thermistor™ IC, Tape and Reel, 5LD SC-70 package.</p> <p>b) MCP9701-E/TO: Linear Active Thermistor™ IC, 3LD TO-92 package.</p> <p>c) MCP9701AT-E/LT: Linear Active Thermistor™ IC, Tape and Reel, 5LD SC-70 package.</p>

MCP9700/9700A and MCP9701/9701A

NOTES:

Note the following details of the code protection feature on Microchip devices:

- Microchip products meet the specification contained in their particular Microchip Data Sheet.
- Microchip believes that its family of products is one of the most secure families of its kind on the market today, when used in the intended manner and under normal conditions.
- There are dishonest and possibly illegal methods used to breach the code protection feature. All of these methods, to our knowledge, require using the Microchip products in a manner outside the operating specifications contained in Microchip's Data Sheets. Most likely, the person doing so is engaged in theft of intellectual property.
- Microchip is willing to work with the customer who is concerned about the integrity of their code.
- Neither Microchip nor any other semiconductor manufacturer can guarantee the security of their code. Code protection does not mean that we are guaranteeing the product as “unbreakable.”

Code protection is constantly evolving. We at Microchip are committed to continuously improving the code protection features of our products. Attempts to break Microchip's code protection feature may be a violation of the Digital Millennium Copyright Act. If such acts allow unauthorized access to your software or other copyrighted work, you may have a right to sue for relief under that Act.

Information contained in this publication regarding device applications and the like is provided only for your convenience and may be superseded by updates. It is your responsibility to ensure that your application meets with your specifications. MICROCHIP MAKES NO REPRESENTATIONS OR WARRANTIES OF ANY KIND WHETHER EXPRESS OR IMPLIED, WRITTEN OR ORAL, STATUTORY OR OTHERWISE, RELATED TO THE INFORMATION, INCLUDING BUT NOT LIMITED TO ITS CONDITION, QUALITY, PERFORMANCE, MERCHANTABILITY OR FITNESS FOR PURPOSE. Microchip disclaims all liability arising from this information and its use. Use of Microchip devices in life support and/or safety applications is entirely at the buyer's risk, and the buyer agrees to defend, indemnify and hold harmless Microchip from any and all damages, claims, suits, or expenses resulting from such use. No licenses are conveyed, implicitly or otherwise, under any Microchip intellectual property rights.

Trademarks

The Microchip name and logo, the Microchip logo, Accuron, dsPIC, KEELOQ, microID, MPLAB, PIC, PICmicro, PICSTART, PRO MATE, PowerSmart, rfPIC, and SmartShunt are registered trademarks of Microchip Technology Incorporated in the U.S.A. and other countries.

AmpLab, FilterLab, Migratable Memory, MXDEV, MXLAB, SEEVAL, SmartSensor and The Embedded Control Solutions Company are registered trademarks of Microchip Technology Incorporated in the U.S.A.

Analog-for-the-Digital Age, Application Maestro, dsPICDEM, dsPICDEM.net, dsPICworks, ECAN, ECONOMONITOR, FanSense, FlexROM, fuzzyLAB, In-Circuit Serial Programming, ICSP, ICEPIC, Linear Active Thermistor, Mindi, MiWi, MPASM, MPLIB, MPLINK, PICKit, PICDEM, PICDEM.net, PICLAB, PICtail, PowerCal, PowerInfo, PowerMate, PowerTool, REAL ICE, rFLAB, rfPICDEM, Select Mode, Smart Serial, SmartTel, Total Endurance, UNI/O, WiperLock and ZENA are trademarks of Microchip Technology Incorporated in the U.S.A. and other countries.

SQTP is a service mark of Microchip Technology Incorporated in the U.S.A.

All other trademarks mentioned herein are property of their respective companies.

© 2006, Microchip Technology Incorporated, Printed in the U.S.A., All Rights Reserved.

 Printed on recycled paper.

QUALITY MANAGEMENT SYSTEM
CERTIFIED BY DNV
== ISO/TS 16949:2002 ==

Microchip received ISO/TS-16949:2002 certification for its worldwide headquarters, design and wafer fabrication facilities in Chandler and Tempe, Arizona, Gresham, Oregon and Mountain View, California. The Company's quality system processes and procedures are for its PICmicro® 8-bit MCUs, KEELOQ® code hopping devices, Serial EEPROMs, microperipherals, nonvolatile memory and analog products. In addition, Microchip's quality system for the design and manufacture of development systems is ISO 9001:2000 certified.



MICROCHIP

WORLDWIDE SALES AND SERVICE

AMERICAS

Corporate Office

2355 West Chandler Blvd.
Chandler, AZ 85224-6199
Tel: 480-792-7200
Fax: 480-792-7277
Technical Support:
<http://support.microchip.com>
Web Address:
www.microchip.com

Asia Pacific Office

Suites 3707-14, 37th Floor
Tower 6, The Gateway
Harbour City, Kowloon
Hong Kong
Tel: 852-2401-1200
Fax: 852-2401-3431

Atlanta

Alpharetta, GA
Tel: 770-640-0034
Fax: 770-640-0307

Boston

Westborough, MA
Tel: 774-760-0087
Fax: 774-760-0088

Chicago

Itasca, IL
Tel: 630-285-0071
Fax: 630-285-0075

Dallas

Addison, TX
Tel: 972-818-7423
Fax: 972-818-2924

Detroit

Farmington Hills, MI
Tel: 248-538-2250
Fax: 248-538-2260

Kokomo

Kokomo, IN
Tel: 765-864-8360
Fax: 765-864-8387

Los Angeles

Mission Viejo, CA
Tel: 949-462-9523
Fax: 949-462-9608

San Jose

Mountain View, CA
Tel: 650-215-1444
Fax: 650-961-0286

Toronto

Mississauga, Ontario,
Canada
Tel: 905-673-0699
Fax: 905-673-6509

ASIA/PACIFIC

Australia - Sydney

Tel: 61-2-9868-6733
Fax: 61-2-9868-6755

China - Beijing

Tel: 86-10-8528-2100
Fax: 86-10-8528-2104

China - Chengdu

Tel: 86-28-8676-6200
Fax: 86-28-8676-6599

China - Fuzhou

Tel: 86-591-8750-3506
Fax: 86-591-8750-3521

China - Hong Kong SAR

Tel: 852-2401-1200
Fax: 852-2401-3431

China - Qingdao

Tel: 86-532-8502-7355
Fax: 86-532-8502-7205

China - Shanghai

Tel: 86-21-5407-5533
Fax: 86-21-5407-5066

China - Shenyang

Tel: 86-24-2334-2829
Fax: 86-24-2334-2393

China - Shenzhen

Tel: 86-755-8203-2660
Fax: 86-755-8203-1760

China - Shunde

Tel: 86-757-2839-5507
Fax: 86-757-2839-5571

China - Wuhan

Tel: 86-27-5980-5300
Fax: 86-27-5980-5118

China - Xian

Tel: 86-29-8833-7250
Fax: 86-29-8833-7256

ASIA/PACIFIC

India - Bangalore

Tel: 91-80-4182-8400
Fax: 91-80-4182-8422

India - New Delhi

Tel: 91-11-5160-8631
Fax: 91-11-5160-8632

India - Pune

Tel: 91-20-2566-1512
Fax: 91-20-2566-1513

Japan - Yokohama

Tel: 81-45-471-6166
Fax: 81-45-471-6122

Korea - Gumi

Tel: 82-54-473-4301
Fax: 82-54-473-4302

Korea - Seoul

Tel: 82-2-554-7200
Fax: 82-2-558-5932 or
82-2-558-5934

Malaysia - Penang

Tel: 60-4-646-8870
Fax: 60-4-646-5086

Philippines - Manila

Tel: 63-2-634-9065
Fax: 63-2-634-9069

Singapore

Tel: 65-6334-8870
Fax: 65-6334-8850

Taiwan - Hsin Chu

Tel: 886-3-572-9526
Fax: 886-3-572-6459

Taiwan - Kaohsiung

Tel: 886-7-536-4818
Fax: 886-7-536-4803

Taiwan - Taipei

Tel: 886-2-2500-6610
Fax: 886-2-2508-0102

Thailand - Bangkok

Tel: 66-2-694-1351
Fax: 66-2-694-1350

EUROPE

Austria - Wels

Tel: 43-7242-2244-3910
Fax: 43-7242-2244-393

Denmark - Copenhagen

Tel: 45-4450-2828
Fax: 45-4485-2829

France - Paris

Tel: 33-1-69-53-63-20
Fax: 33-1-69-30-90-79

Germany - Munich

Tel: 49-89-627-144-0
Fax: 49-89-627-144-44

Italy - Milan

Tel: 39-0331-742611
Fax: 39-0331-466781

Netherlands - Drunen

Tel: 31-416-690399
Fax: 31-416-690340

Spain - Madrid

Tel: 34-91-708-08-90
Fax: 34-91-708-08-91

UK - Wokingham

Tel: 44-118-921-5869
Fax: 44-118-921-5820

06/08/06